

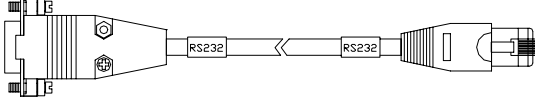
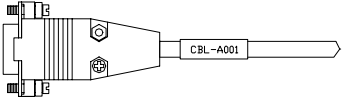
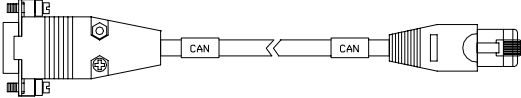
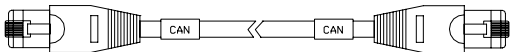
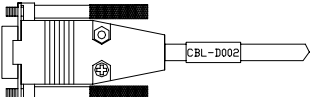
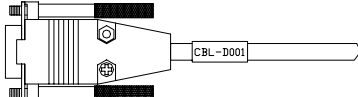
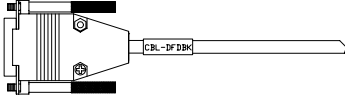
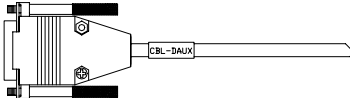

Cornet

Digital Servo Drive Cable Kits

 <p>COMM.1: (RS-232)</p>	<p>CBL-RJ452321 CBL-RJ452321-5</p>
 <p>Analog Inputs: CBL-A001 CBL-A001-5</p>	 <p>COMM.2: (CAN) CBL-RJ45CAN1 CBL-RJ45CAN1-5</p>  <p>COMM.2: (CAN) CBL-RJ45CAN2 CBL-RJ45CAN2-5</p>
 <p>COMMITTED I/O: CBL-D002 (Digital Inputs) CBL-D002-5</p>	 <p>General I/O: CBL-D001 (Digital Outputs) CBL-D001-5</p>
 <p>Feedback A: CBL-DFDBK CBL-DFDBK-5</p>	
 <p>Feedback B: CBL-DAUX CBL-DAUX-5</p>	
 <p>Aux. Power: CBL-CEL24 CBL-CEL24-5</p>	 <p>Motor Power Cable: (General Purpose) CBL-MTRPWR CBL-MTRPWR-5</p>
 <p>Motor Power: (for SAR, SA,SB,SC) CBL-MTRPWR1 CBL-MTRPWR1-5</p>	 <p>Motor Power: (for SE) CBL-MTRPWR2 CBL-MTRPWR2-5</p>

Important Notice

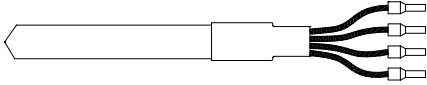
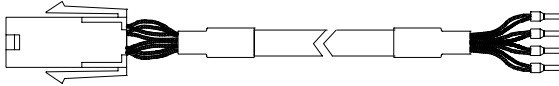
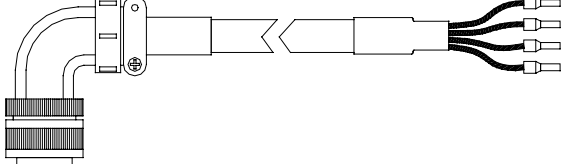
This guide is delivered subject to the following conditions and restrictions:

- This guide contains proprietary information belonging to Elmo Motion Control Ltd. Such information is supplied solely for the purpose of assisting users of Elmo's Cornet servo drives in assembling the required cables for their drive.
- The text and graphics included in this manual are for the purpose of illustration and reference only. The specifications on which they are based are subject to change without notice.
- Information in this document is subject to change without notice.

Doc. No. MAN-CBLKIT-COR

Copyright ©2006

Elmo Motion Control Ltd.

All rights reserved.

Revision History

Document version 1.1: June 2006 New photos (MAN-CBLKIT-COR.pdf)

Document version 1.0: February 2005 (MAN-CBLKIT-COR.pdf)

Elmo Motion Control Inc.
1 Park Drive, Suite 12
Westford, MA 01886
USA
Tel: +1 978 399-0034
Fax: +1 978 399-0035
info-us@elmomc.com

Elmo Motion Control GmbH
Steinkirchring 1
D-78056, Villingen-Schwenningen
Germany
Tel: +49 07720 8577-60
Fax: +49 07720 8577-70
info-de@elmomc.com



Elmo
Motion Control
www.elmomc.com

Contents

1. Introduction	1
1.1 Cornet Connectors.....	1
1.2 Cable Cross-Reference.....	2
2. Cable Kits	3
3. Communication Cables	4
3.1 RS-232 Serial Communications (CBL-RJ452321-5).....	4
3.2 CAN Communications (CBL-RJ45CAN1-5)	5
3.3 CAN-CAN Daisy-Chain (CBL-RJ45CAN2)	6
4. I/O Cables.....	7
4.1 Analog Inputs (CBL-A001-5).....	7
4.2 Digital Inputs (CBL-D002-5).....	8
4.3 Digital Outputs (CBL-D001-5)	9
5. Feedback Cables	10
5.1 Main Feedback Cable (CBL-DFDBK-5).....	10
5.2 Auxiliary Feedback Cable (CBL-DAUX-5)	11
6. Power Cables	12
6.1 Auxiliary Power Cable (CBL-CEL24-5).....	12
6.2 Motor Power Cable (CBL-MTRPWR-5).....	12
6.3 Motor Power Cable (CBL-MTRPWR1-5)	13
6.4 Motor Power Cable (CBL-MTRPWR2-5)	13

1. Introduction

This document provides the wiring details for the cables used to connect Cornet digital servo drives with the end-user application. The servo drive-side pinouts are provided in Chapter 3 of the drive’s installation guide.

The cables come in two lengths: 2 meters (6 ½ feet) and 5 meters (16 ½ feet). The cable length is indicated in the cable part number by use of an extended suffix to indicate 5 meter length. For example, cable CBL-DAUX is a 2 meter cable while CBL-DAUX-5 is a 5 meter cable.

CBL-RJ45CAN2, is an exception, it is only 20 cm long.

1.1 Cornet Connectors

The **Cornet** has the following connectors:

Type	Function	Port on Cornet	Connector Location
8-pin RJ-45	RS-232	COMM. 1	
9 pin D-sub socket	Analog Input	ANALOG INPUTS	
8-pin RJ-45, RJ-45	CAN ... CAN (CANopen)	COMM. 2	
15-pin high-density D-sub plug	Digital Inputs	COMMITTED I/O	
15-pin high-density D-sub socket	Digital Outputs	GENERAL I/O	
15-pin D-sub socket	Main feedback	FEEDBACK A	
15-pin D-sub plug	Auxiliary Feedback	FEEDBACK B	
2-pin terminal strip Molex	Auxiliary power supply	+, -	
8-pin terminal block Molex	Mains and motor power	M1, M2, M3, PE, PE, AC1, AC2, AC3	

Table 1-1: Connectors on the Cornet

1.2 Cable Cross-Reference

Cable Application	Cable Part. No.	No. of Pins	Label on Cornet	pg
RS-232 Communications	CBL-RJ452321-5	8	COM.1	4
CAN Communications	CBL-RJ45CAN1-5	8	COMM.2	5
CAN-CAN Daisy-Chain	CBL-RJ45CAN2-5	8		6
Analog Inputs	CBL-A001-5		ANALOG INPUTS	7
Digital Inputs	CBL-D002-5		COMMITTED I/O	8
Digital Outputs	CBL-D001-5		GENERAL I/O	9
Main Feedback (gnrl-purp.)	CBL-DFDBK-5	15	FEEDBACK A	10
Auxiliary Feedback	CBL-CELDAUX-5	15	FEEDBACK B	11
Auxiliary Power	CBL-CEL24-5	2	+/-	12
Power (gnrl-purpose)	CBL-MTRPWR-5	4	PE/M1/M2/M3	13
Motor (for SAR, SA, SB, SC)	CBL-MTRPWR1-5	4		13
Motor (for SE)	CBL-MTRPWR2-5	4		13

2. Cable Kits

Several Cable Kits can be purchased from Elmo. Each contain a set of 8 cables. The -5 suffix on the kits and on the cables (CBL-DFDBK-5 for example) indicate that the cables are 5m long. Cables and kits without that suffix are 2m long (except for CBL-RJ45CAN2 which is 20cm long). **Customers may purchase cables in kits, or individually in multiples of 10 each.** The contents of the kits are listed below:

Cable Application	Cable Part. No.	CBL-CORKIT01 -CORKIT01-5	CBL-CORKIT02 -CORKIT02-5
RS-232 Communications	CBL-RJ452321-5		
CAN Communications	CBL-RJ45CAN1-5		
CAN -CAN Daisy -Chain	CBL-RJ45CAN2-5		
Analog Inputs	CBL-A001-5		
Digital Inputs	CBL-D002-5		
Digital Outputs	CBL-D001-5		
Main Feedback (gnrl-purpose)	CBL-DFDBK-5		
Auxiliary Feedback	CBL-DAUX-5		
Auxiliary Power	CBL-CEL24-5		
Power (general-purpose)	CBL-MTRPWR-5		
Motor (SAR, SA, SB, SC)	CBL-MTRPWR1-5		
Motor (for SE)	CBL-MTRPWR2-5		

3. Communication Cables

The communication cables use 26-AWG twisted pair shielded cable. They are connected using an 8-pin RJ-45 plug. Elmo drives can communicate using the following options:

- RS-232, full duplex
- CANopen

3.1 RS-232 Serial Communications (CBL-RJ452321-5)

RJ45 Pin No.	Color	D-type Female Pin No.	Signal	Description
3	Brown	2	Tx	RS-232 transmit
5	White	5	COMRET	Communication return
6	Green	3	Rx	RS-232 receive
body	Drain Wire	body	shield	cable shield

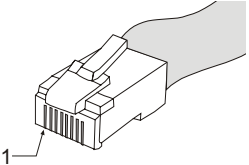



The shields of the RJ-45 and D-type plugs are connected to each other through the cable braid.



Figure 1: RS-232 Communications Cable (Part No. CBL-RJ452321-5)

3.2 CAN Communications (CBL-RJ45CAN1-5)

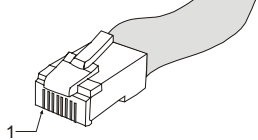
RJ45 Pin No.	Color	D-type Female Pin No.	Signal	Description
1	Green	7	CAN-H	CAN_H bus line
2	Yellow	2	CAN_L	CAN_L bus line
3	White	3	CAN_GND	CAN ground
4	—	—	—	—
5	—	—	—	—
7	—	—	—	—
8	—	—	—	—
body	Drain Wire	body	shield	cable shield



The shields of the RJ-45 and D-type plugs are connected to each other through the cable braid.

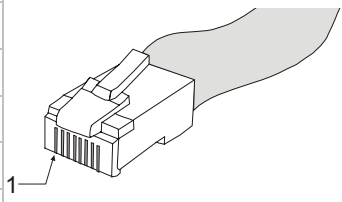

Figure 2: CAN Cable (Part No. CBL-RJ45CAN1-5)

3.3 CAN-CAN Daisy-Chain (CBL-RJ45CAN2)

Cable CBL-RJ45CAN2 is 20 cm long, it is used for “daisy-chaining” CAN nodes.

RJ45 Pin No.	Color	RJ45 Pin No.	Signal	Description
1	Green	1	CAN-H	CAN_H bus line
2	Yellow	2	CAN_L	CAN_L bus line
3	White	3	CAN_GND	CAN ground
4	—	—	—	—
5	—	—	—	—
7	—	—	—	—
8	—	—	—	—
body	Drain Wire	body	shield	cable shield



The shields of the two RJ-45 plugs are connected to each other through the cable braid.



Figure 3: CAN Cable (Part No. CBL-RJ45CAN2)

4. I/O Cables

- Analog Inputs
- Digital Inputs ("COMMITTED I/O")
- Digital Outputs ("GENERAL I/O")

4.1 Analog Inputs (CBL-A001-5)

The digital input cable is a 24-AWG shielded cable. It is connected using an 9-pin D-sub plug.

Pin	Color	Signal	Pair	Function	Pin Position
1	Brown	ANLIN1+	Pair	Analog Input 1	
2	White	ANLIN1-		Analog Input 1	
3	Yellow	ANLRET		Analog Ground	
4	Red	ANLIN2+	Pair	Analog Input 2	
5	Blue	ANLIN2-		Analog Input 2	
6	Pink	GND		Common Return	
9	Green	GND		Common Return	
-				Drain Wire soldered to connector body	



Figure 4: Analog Input Cable (Part No. CBL-A001-5)

4.2 Digital Inputs (CBL-D002-5)

The digital input cable is a 24-AWG shielded cable which attaches to the COMMITTED I/O port on the Cornet. It is connected using an 15-pin Hi-Density D-sub socket.

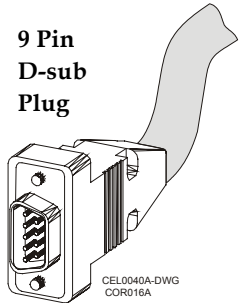
Pin	Color	Signal	Pair	Function	Pin Position
1	Orange	IN1	pair	Programmable input 1	 <p>15 Pin Hi-Density D-sub Socket</p>
6	Cyan	IN2		Programmable input 2	
2	Grey	IN3	pair	Programmable input 3	
7	Pink	IN4		Programmable input 4	
3	Brown	IN5	pair	Programmable input 5	
8	White	IN6		Programmable input 6	
4	Red	IN7	pair	Programmable input 7	
9	Blue	IN8		Programmable input 8	
5	Yellow	IN9	pair	Programmable input 9	
10	Green	IN10		Programmable Input10	
11	Purple	INRET1-2		Prog. Input return 1-2	
12	Black	INRET3-4		Prog. Input return 3-4	
13	White/ Black	INTRET5-6		Prog. Input return 5-6	
14	White/ Red	INTRET7-8		Prog. Input return 7-8	
15	White/ Yellow	INTRET9-10		Prog. Input return 9-10	



Figure 5: Digital Input Cable (Part No. CBL-D002-5)

4.3 Digital Outputs (CBL-D001-5)

The digital output cable is a 26-AWG shielded cable that is connected to the General I/O port on the Cornet. It is connected using a 15-pin Hi-Density D-sub plug.

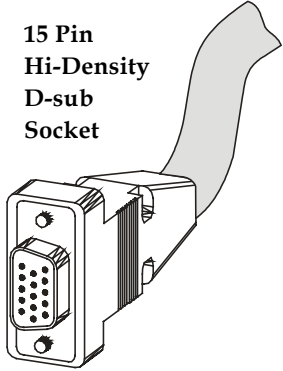
Pin	Color	Signal	Pair	Function	Pin Position
1	Brown	OUT1	pair	Programmable output 1	 <p>15 Pin Hi-Density D-sub Plug</p>
6	White	OUTRET1		Programmable output return 1	
2	Grey	OUT2	pair	Programmable output 2	
7	Pink	OUTRET2		Programmable output return 2	
3	Red	OUT3	pair	Programmable output 3	
8	Blue	OUTRET3		Programmable output return 3	
4	Green	OUT4	pair	Programmable output 4	
9	Yellow	OUTRET4		Programmable output return 4	
5	Orange	OUT5	pair	Programmable output 5	
10	Cyan	OUTRET5		Programmable output return 5	
11	Purple	OUT6	pair	Programmable output 6	
12	Black	OUTRET6		Programmable output return 6	



Figure 6: Digital Output Cable (Part No CBL-D001-5)

5. Feedback Cables

The main feedback cables are made of 24-AWG shielded cable. The feedback cable has a 15-pin D-sub plug which connects to the FEEDBACK A port on the Cornet.

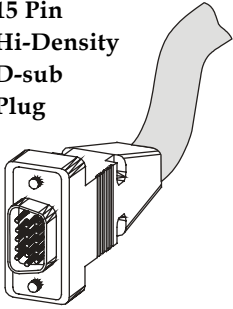
- The Main Feedback Cable (CBL-DFDBK) is open on the motor side so that it can be connected to customer-specific connectors.
- Encoder Cable CBL-MTRENC2 has a 15-pole socket on the motor side for Metronix APM-SAR, SA, SB and SC motors.
- Encoder Cable CBL-MTRENC4 has a 17-pole Amphenol socket on the motor side for Metronix APM-SE motors.

5.1 Main Feedback Cable (CBL-DFDBK-5)



Pin No.	Color	Pairs		
1	Green	pair	 <p>15 Pin D-sub Plug</p>	
10	Yellow			
2	Pink			
3	White	pair		
4	Brown			
5	Orange	pair		
6	Cyan			
7	Blue	pair		
8	Red			
9	-			
11	-			
12	-			
13	-			
14	Black	pair		 <p>The specific functionality of each pin is fully outlined in the <i>Cornet Installation Guide</i> (MAN-CORIG).</p>
15	Purple			



Figure 7: Single-sided Main Feedback Cable (Part No. CBL-DFDBK-5)

5.2 Auxiliary Feedback Cable (CBL-DAUX-5)

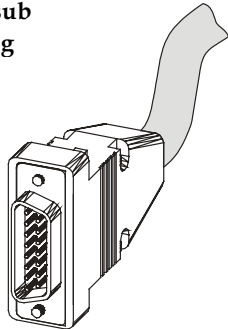
The auxiliary feedback cable is a 24-AWG shielded cable. It is connected using an 15-pin D-sub plug which connects to the Cornet’s FEEDBACK B port.

Four options – described in the Auxiliary Feedback section of the *Cornet Installation Guide* – are available for auxiliary feedback:

- Main encoder buffered outputs
- Differential encoder inputs
- Single-ended encoder input
- Pulse-and-direction input

The general pinout of the auxiliary feedback cable is as follows:

Port	Pin	Color	Pair	Description	Pin Position
B1	1	red	pair	see Installation Guide	
B1	9	Blue			
B1	2	Purple	pair	see Installation Guide	
B1	10	Black			
B1	3	Cyan	pair	see Installation Guide	
B1	11	Orange			
B1	5	White/Yellow		SUPRET	
B2	6	Pink	pair	see Installation Guide	
B2	13	Grey			
B2	7	Yellow	pair	see Installation Guide	
B2	14	Green			
PWR	8	White-Red	pair	see Installation Guide	
PWR	15	White/Black			
B2	12	White		SUPRET	
B1	4	Brown		+5V	



Figure 8: Auxiliary Feedback Cable (Part No. CBL-DAUX-5)

6. Power Cables

6.1 Auxiliary Power Cable (CBL-CEL24-5)

The auxiliary power cable is a 24-AWG shielded cable terminated by pins on the *SimplIQ* side. The pins are screwed into the 2-pole Pheonix Terminal Block provided with the Cornet.

Pin No.	Color	Twisted & Shielded Wire	Signal	Description
1	Red	Pair	+24VDC	+24 VDC auxiliary power supply
2	Black		RET24VDC	Return (common) of 24 VDC auxiliary power supply



Figure 9: Auxiliary Power Cable (Part No. CBL-CEL24-5)

6.2 General Purpose Power Cable (CBL-MTRPWR-5)

CBL-MTRPWR is a general-purpose motor power cable. It is made from four 14-AWG shielded wires with pin terminals on the Cornet drive. The pins are connected to the Pheonix Terminal Block supplied with the Cornet. The other end is open so that it can be attached to a customer-specific connector.

Color	Signal	Description
White	M1	Motor Phase 1 (U)
Black	M2	Motor Phase 2 (V)
Red	M3	Motor Phase 3 (W)
Green	PE	Ground

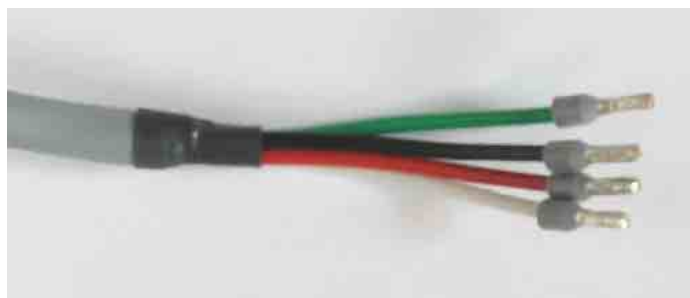

Figure 10: General-Purpose Power Cable (Part No. CBL-MTRPWR-5)

6.3 Motor Cable (CBL-MTRPWR1-5)

CBL-MTRPWR1-5 is a 24-AWG shielded cable in which each wire, on the *SimplIQ* drive side, is connected to a pin terminal and the wires on the motor side are connected to a 4-pole socket. This cable is designed for connecting a Cornet to a Metronix APM-SAR, SA, SB or SC motor.

Color	Signal Drive Side	Description	AMP Pin No. Motor Side
Brown & White	M1	Motor Phase 1 (U)	1
Pink & Grey	M2	Motor Phase 2 (V)	2
Blue & Red	M3	Motor Phase 3 (W)	3
Green & Yellow	PE	Ground	4



Figure 11: SAR, SA, SB, SC-type Motor Cable (Part No. CBL-MTRPWR1-5)

6.4 Motor Cable (CBL-MTRPWR2-5)

CBL-MTRPWR2 is designed to provide power to Metronix SE motors. It is made from four 14-AWG shielded wires with pin terminals on the Cornet side. The other end has an Amphenol 4-pole socket so that it can be attached to an Amphenol plug on the motor.

Color	Signal Drive Side	Description	Amphenol Pin No. Motor Side
White	M1	Motor Phase 1 (U)	A
Black	M2	Motor Phase 2 (V)	B
Red	M3	Motor Phase 3 (W)	C
Green + Braid	PE	Ground	D



Figure 12: SE-type Motor Cable (Part No. CBL-MTRPWR2-5)